

# MOSO<sup>®</sup> Bamboo X-treme<sup>®</sup> outdoor products

WARRANTY  
**25**  
YEARS



Ron Turner Studios



Hover Imagery



André Clemetsen

mOSO<sup>®</sup>

# bamboo: the fastest growing plant in the world



## certified

durable & sustainable



fire resistant



## proven

Since 2008 over  
45 million sqft  
installed, in  
more than  
60 countries.

## complete range

- Decking & Deck Tiles
- 1x4 T&G
- Soffit, Trim & Fascia Boards
- Siding
- Fencing
- 2x Beams

# high stability: end-match system



# MOSO<sup>®</sup>

## Bamboo X-treme<sup>®</sup>

With Bamboo X-treme<sup>®</sup>, MOSO<sup>®</sup> has developed an **ecologically sustainable** and **durable** exterior product. MOSO<sup>®</sup> uses a unique Thermo-Density<sup>®</sup> process to enhance the **hardness, dimensional stability, fire resistance** and **durability**, compared to other natural exterior products. The MOSO<sup>®</sup> Bamboo X-treme<sup>®</sup> range includes **Decking, Deck Tiles, 1x4 T&G, Soffit, Trim & Fascia Boards, Siding, Fencing** and **2x Beams**.

### table of contents

from bamboo to <b>Bamboo X-treme<sup>®</sup></b>	4
benefits	5
<b>Bamboo X-treme<sup>®</sup> Outdoor Decking</b>	<b>6</b>
accessories	8
installation	9
maintenance & cleaning	11
<b>Bamboo X-treme<sup>®</sup> Outdoor 2x2 Deck Tile</b>	<b>12</b>
<b>Bamboo X-treme<sup>®</sup> 1x4 T&amp;G</b>	<b>14</b>
installation	16
<b>Bamboo X-treme<sup>®</sup> Soffit, Trim &amp; Fascia Boards</b>	<b>17</b>
<b>Bamboo X-treme<sup>®</sup> Outdoor Siding</b>	<b>18</b>
installation	20
<b>Bamboo X-treme<sup>®</sup> Outdoor Fencing</b>	<b>22</b>
<b>Bamboo X-treme<sup>®</sup> 2x Beams</b>	<b>24</b>
test results	26
sustainability	28
user information	29
endless possibilities	30



**High Bluff Ridge**  
(1500 sqft) San Diego, California, United States of America

Fraser Decks & Patio Covers  
Hover Imagery

# from bamboo to Bamboo X-treme®

The fast growth and abundant availability makes bamboo a perfect source for many applications in and around buildings. With good reason, it's often called **'the building material of the future'**. However, bamboo as a raw material cannot be used outdoors without a protective treatment. Due to its high "sugar"-components, bamboo is more susceptible to being attacked by micro-organisms and fungi. Let us explain how we get from the raw bamboo material to the final product, MOSO® Bamboo X-treme®, through a production process called Thermo-Density®.

## stem to strands

After harvesting, the mature Moso bamboo stems are split in a longitudinal direction and the outer and inner skins are removed. The strips are then crushed by using a number of incision rollers which slice gaps into the strips and then (by pressure) grind the strips to loose strands. The untreated strands have a light yellow color.

## thermal treatment

In several steps, the strands are heated up to 392°F in the presence of a saturated steam (to protect the wood from charring or burning) and cooled down. During processing, the moisture content and sugar content change. Furthermore, this process changes the color of the bamboo from white/yellow to deep/dark brown.

## from strands to product

The dark bamboo strands are dipped into phenolic glue (< 10% of the weight of the bamboo). After drying, the strands are put into a mould, and are then compressed under high temperature and at a very high pressure, to cure the glue. The output is a large panel, which is cut into smaller sections (boards or beams). These are then further machined and profiled to get the required shape (for example, for decking: a grooved surface and edge grooved along the sides to allow installation with fasteners).

## Thermo-Density®

We call the combination of compressing and thermally treating strands a Thermo-Density® process. It increases the density from 650-700 kg/m<sup>3</sup> to approx. 71.79 lbs/ft<sup>3</sup> and improves the hardness of this product significantly. After pressing, the material is stronger and harder than almost any other hardwood in the world. At the same time, the dimensional stability of bamboo is improved by approximately 50%.

Besides stability and hardness improvements, the durability is improved to the best durability class possible, from Class 5 to Class 1: Class 1 (EN 350) CEN/TS 15083-2 - simulated graveyard test and Class 1 (EN 350) CEN/TS 15083-1.

## durability class according to EN 350 (CEN/TS 15083-2 / CEN/TS 15083-1)

	5	4	3	2	1
MOSO® Bamboo X-treme®					
Ipé					
Bangkirai					
Oak					
Strand Woven Bamboo					
Scots Pine					

▨ range of durability results

MOSO® Bamboo X-treme® is also well protected against superficial fungi Class 0 (EN 152), and achieves the use/risk Class 4 according to EN 335.

**Only MOSO® can ensure you have the original, unique Bamboo X-treme® product.** Other products that attempt to copy the original, do not offer the same quality or level of durability, dimensional stability and ecology. With a look-alike product, there is a large risk of claims after installation. **Always ask for the original, certified MOSO® Bamboo X-treme® products!**

harvesting after 4-5 years



modify the bamboo strands with a heat-treatment at 200°C



split the Moso bamboo stems, remove the outer skin and crush the strips into strands



compressing the strands into Thermo-Density® material



finally creating the final profile and surface

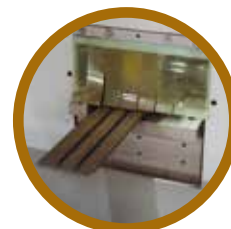

**MOSO® Bamboo X-treme®:** material more stable, harder and stronger than almost any other hardwood in the world!

# discover the **Bamboo** X-treme® benefits



## hard & durable

- Bamboo decking with Durability Class 1 (EN 350) tested following CEN/TS 15083-2 class (simulated graveyard test).
- Use Class 4 in accordance with EN 335.
- Fungi resistance Class 0 in accordance with EN 152.
- Exceptionally hard: Brinell >9.5kg/mm<sup>2</sup> (harder than any tropical hardwood available).
- MOSO provides Bamboo X-treme® outdoor products\* with up to 25 years warranty.

\*) Bamboo X-treme® Decking, Deck Tiles, 1x4 T&G, Soffit, Trim & Fascia Boards, Siding, Fencing and Sub Frame Joist.

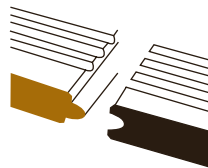

## high stability

- Very stable as a result of the "Thermo-Density®" process of heat-treatment combined with High Density® compression.
- Far more stable than tropical hardwoods - enabling end-match system (tongue & groove on ends).
- Limited tendency to torsion.
- No gap between the ends of the boards necessary.
- Only 3/16" expansion gap between boards.
- Possible to use pressure treated lumber or metal for joists.

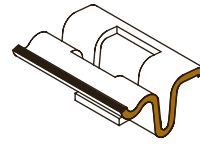

## easy to install

- Can be installed using hidden fasteners (edge grooved) or face screwed.
- Both sides of the board - grooved or smooth - can be used.
- Fixed board length 6', easy for 1 person to install.
- MOSO® Fasteners make it easy to install and uninstall.
- End-match system simplifies the installation by allowing the joint to float between the joists.
- Complementing Thermo-Density® sub frame joists available.



## economical

- Simple and fast installation: Up to 30% savings in installation costs!
- Reduced waste because of the end-match system.
- Cost effective transportation because of the fixed 6' length.
- Cost effective and space reducing stocking because of unique multi usable board.



## beautiful appearance

- A beautiful, natural hardwood look.
- Choice for smooth or grooved surface in one reversible board.
- Use of hidden fasteners reduces face screwing and plugging.
- Free of knots and natural plant resins.
- Choice for natural fading, resulting in a natural grey color or maintaining the rich brown color using an exterior finish.



## endless resource

- Made from Moso bamboo; With a growing speed of up to 3' per day the fastest growing plant on earth.
- Ready for harvest after 4-5 years (compared to up to 100 years for hardwood species) - no deforestation.
- Consisting of approx. 90% natural bamboo.



## CO<sub>2</sub> neutral

- Official LCA and carbon footprint studies by Technical University Delft according to ISO 14040/44 confirm that MOSO® Bamboo X-treme® is CO<sub>2</sub> neutral over the full life cycle.
- No use of fungicide in the production.



## fire resistant

- Achieves a Class A rating under ASTM E84. CAN/ULC-S102 achieved indexes for Flame Spread of 25 and Smoke Developed of 45.
- Reaches fire resistance Class Bfl-s1 (decking, 1x4 T/G) and B-s1-d0 (siding, fascia/trim boards) following EN 13501-1 without use of fire retardants.
- The bamboo decking and siding products that meet the California fire code requirements for WUI (Wildfire Urban Interface) zones.



Fraser Decks & Patio Covers  
 Hover Imagery

**Solana Beach Private Residence** California, United States of America



WATG Arquitectos /  
 Idea Asociados de Mexico  
 Cristian Costea

**Hard Rock Hotel Los Cabos**  
 (16,146 sqft) Los Cabos, Mexico

**La Jolla Private Residence**  
 (900 sqft) Copa De Oro, La Jolla, United States of America



Hover Imagery

# MOSO® Bamboo X-treme® Outdoor Decking

MOSO® Bamboo X-treme® is a solid, Thermo-Density® decking board, made from compressed bamboo strips. A special, heat-treatment process at 392°F (200°C) provides MOSO® Bamboo X-treme® the highest durability class possible in the appropriate European standard (see technical characteristics below) and increases the hardness and stability. A unique feature of MOSO® Bamboo X-treme® is the end-matched connection: this can only be done with very stable materials and enables connection of an unlimited number of boards in the length. The special symmetrical shape of the sides offers the possibility to choose between either the standard groove or the smooth surface, and allows for quick installation with MOSO® Fasteners. Bamboo X-treme® will weather over time to a silver patina.

1 x 4 x 6  
Board unfinished with tongue  
G2 / Smooth (reversible)



1 x 6 x 6  
Board finished with tongue  
G1 / Smooth (reversible)

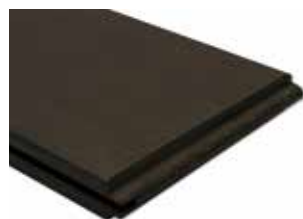

1 x 8 x 6  
Board finished with groove  
G2 / Smooth (reversible)



End-matched

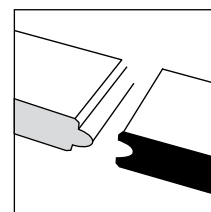

High Density\*



\*) Also on ends.

Unfinished	Grooved	Edges*	Surface	End-matched	Size	Dimensions (")	Dimensions (mm)
BO-DK20-G2-96UF	Both sides	Macro Bevel	Smooth/Smooth	Yes	1 x 4 x 6	3/4 x 3 7/8 x 72	20 x 96 x 1830
BO-DK20-G0-96UF	Not grooved	Eased Edge	Smooth/Smooth	No	1 x 4 x 6	3/4 x 3 7/8 x 72	20 x 96 x 1830
BO-DK20-G2-UF	Both sides	Macro Bevel	Standard Groove/Smooth	Yes	1 x 6 x 6	3/4 x 5-3/8 x 72	20 x 137 x 1830
BO-DK20-G1-UF	One side	Macro Bevel	Standard Groove/Smooth	Yes	1 x 6 x 6	3/4 x 5-3/8 x 72	20 x 137 x 1830
BO-DK23-G2-UF	Both sides	Macro Bevel	Standard Groove/Smooth	Yes	1 x 8 x 6	3/4 x 7 x 72	20 x 178 x 1830

## installation summary

- Install a suitable, fixed, stable and durable joist system.
- Determine which side of the board will be used: the standard groove or smooth surface.
- Don't forget to make sure that there is adequate airflow below the deck especially when installing in a low rise atmosphere. Even though Bamboo X-treme® Decking can be installed closer to the ground than any other natural material, proper air flow is a separate issue and can have an adverse effect on the deck if not properly done.
- Fix the boards on the joist system using hidden fasteners (to be inserted in the grooves of the board) or alternatively with screws (through the surface).
- End-matched system can be floated off joist on 16" centers to minimize the waste.
- Don't forget to make sure you float a fastener at the end-match when floating the joint. The fastener will provide added support and maintain proper spacing between the boards.
- Use a 1-2% slope and ensure good ventilation is available.
- Unfinished Bamboo X-treme® Decking can be left to weather naturally or can be finished 3-4 months after installation.
- When not applying outdoor oil regularly, the deck will acquire a grey color tone and the typical bamboo grain structure will become less visible.
- After installation: make sure proper cleaning and maintenance is done, according to the chosen finish.
- For further info: please see the installation/maintenance instructions.
- Store in a cool and dry place away from direct sunlight, and protected from weather influences, dirt and dust.
- Full version available at ▶ [www.moso-bamboo.com/x-treme/decking](http://www.moso-bamboo.com/x-treme/decking)

## technical characteristics and certifications

- Density: +/- 71.79 lbs/ft<sup>3</sup>
- Dimensional stability:  
length: + 0.1%; width + 0.9% (24 hours in water 68°F)
- Resistance to Indentation - Brinell Hardness: ≥ 1,350 psi (EN 1534)
- Reaction to fire: Class Bfl-s1 (EN 13501-1)
- Flame spread index: Flame spread 25, Smoke developed 45  
Class A (ASTM E84) / CAN/ULC S102 (WUI approved)
- Slip resistance - new material: USRV 55 (Dry), USRV 29 (Wet), USRV 91 (Dry), USRV 42 (Wet) (Pendulum friction test - CEN/TS 16165 Annex C - CEN/TS 15676) / R 10 (Shod ramp test - CEN/TS 16165 Annex B - DIN 51130) / Class C (Barefoot ramp test - CEN/TS 16165 Annex A - DIN 51097)
- Slip resistance - weathered material: USRV 100 (Dry) (CEN/TS 16165 Annex C) / R 11 (CEN/TS 16165 Annex B - DIN 51130)
- Thermal emittance: 0.81 (ASTM C1371)<sup>1)</sup>
- Solar Reflectance (SR): 0.32 (ASTM C1549)<sup>1)</sup>
- Solar Reflectance Index (SRI): Low 27, Medium 30, High 33 (ASTM E1980)<sup>1)</sup>
- Modulus of Elasticity: 13565 MPa (EN 408, equivalent ASTM D 198)
- Bending strength: 54.4 MPa (EN 408, equivalent ASTM D 198)
- Biological durability: Class 1 (EN 350 / CEN/TS 15083-2), simulated graveyard test / Class 1 (EN 350 / CEN/TS 15083-1)
- Effectiveness against Blue Stain: Class 0 (EN 152)
- Use Class: Class 4 (EN 335)
- CO<sub>2</sub> neutral: LCA report TU Delft (ISO 14040/44) ([www.moso-bamboo.com/lca](http://www.moso-bamboo.com/lca))
- Environmental Product Declaration - EPD (EN 15804) ([www.moso-bamboo.com/epd](http://www.moso-bamboo.com/epd))
- FSC®: Products available with FSC® certification on request.
- Contribution LEED BD+C - v4: MR 1, MR 2, MR 3 (FSC®), EQ 2, SS 7 v2009: MR 6, MR 7 (FSC®), IEQ 4, 3, IEQ 4.4
- Contribution BREEAM: MAT 1, MAT 3 (FSC®), MAT 5 (HD)
- Warranty: 25 years

<sup>1)</sup> Tested on 3 years weathered MOSO® Bamboo X-treme®.

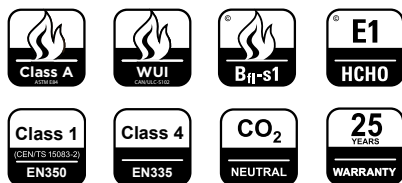

Only available on special request.



The mark of responsible forestry  
FSC® C002063



breeam

# MOSO® Bamboo X-treme® Outdoor Decking & Siding accessories

## MOSO® Fasteners

With these fasteners MOSO® Bamboo X-treme® Decking and Siding can be easily installed. When installed correctly there will be 3/16" gap between the boards. The fasteners are supplied with matching stainless steel screws (square bit). For installation on aluminium sub frame joist, special screws are available.

Product Code	Item	Material	Color	Dimensions (")	Dimensions (mm)
CLIP-SCREW-BX08	Fastener Asymmetric with screw (20 mm)	Stainless steel A2 (AISI304)	Brown	11/6 x 57/64 x 27/64	27 x 22.5 x 10.8
	Screw	Stainless steel A2 (AISI304)	Brown		4.5 x 30
CLIP-BX08	Fastener Asymmetric without screw	Stainless steel A2 (AISI304)	Brown	11/6 x 57/64 x 27/64	27 x 22.5 x 10.8
SCREW-09	Screw for aluminium sub frame joist	Stainless steel A2 (AISI304)	Brown		4.2 x 20

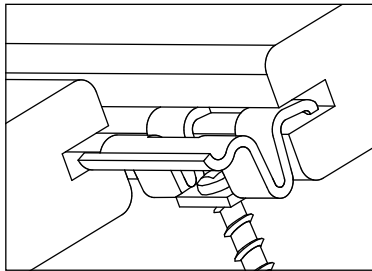

CLIP-SCREW-BX08  
CLIP-BX08



## Usage fastener / sqft

Bamboo X-treme® width	on center		
	16" / 406 mm	18" / 457 mm	24" / 610 mm
3 7/8" / 96 mm	2.65	2.12	1.8
5 3/8" / 137 mm	1.85	1.48	1.11
7" / 178 mm	1.43	1.14	0.86

## MOSO® Bamboo X-treme® Sub Frame Joists

MOSO® Bamboo X-treme® Sub Frame Joists are made out of the same Thermo-Density® material as the decking. These joists are perfect for pedestal applications including patio recover and roof decks.

Pedestal sold separately.

Product Code	Material	Finish	Profile	Size	Dimensions (")	Dimensions (mm)
BO-SB155	Thermo Density® bamboo	Unfinished	S4S E4E	2 x 3	1 1/2 x 2 3/8 x 96	40 x 60 x 2440





# MOSO® Bamboo X-treme® Outdoor Decking

## installation instructions

### before installation

- Local building codes must always be consulted when building an exterior deck. Most counties require building permits.
- Water logging under the decking must be avoided by preparing a water permeable ground structure. This can be achieved by sand layers and gravel dispersion above.
- Install the decking boards with a slope of 1-2% to enable water to run off the surface. Alternatively, the decking can be installed without a slope, but due to the fact that water stays on the surface longer, it is possible more superficial cracks will develop. If the installation is done without slope more cleaning will be required.
- There must be adequate air circulation underneath the deck to prevent cupping and warping of the boards.
- When working in low clearance situations it is very important that adequate airflow is factored into the installation. Lack of airflow can cause heat to collect and will have an aesthetic affect on the decking.
- When the surface underneath the decking is not fast drying, there should be at least 4" distance between the decking and the surface underneath the floor.
- In applications where the deck is being built closer to wet ground, a vapor barrier is recommended to prevent water from absorbing into the underside of the material.
- In order to create a stable deck frame, the outsides of the frame have to be connected at regular intervals to the ground/ structure below. Alternatively cross bracing can be applied.

### safety

Drilling, sawing, sanding, and machining MOSO® Bamboo X-treme® generates dust. Avoid inhaling dust by wearing a dust mask. Contact MOSO® for MSDS information.

### required tools

- Drill
- Drill bits
- Safety glasses
- Power screw gun with ratcheting torque setting
- Chop saw
- MOSO® Bamboo X-treme® can be crosscut with a quality chop saw, using a carbide-tipped blade. Ripping can be done on a standard table saw, using a properly aligned quality fence with a carbide-tipped blade.
- MOSO® Bamboo X-treme® can be routed or planed with high-speed steel or carbide cutters. When required, only sand in the direction of the grain - i.e. belt sander. Never use an orbital sander.

### the installation

#### spacing

- Keep at least 3/16" expansion gap between the boards (in width direction). With MOSO® Bamboo X-treme® Fasteners installation this is automatically the case.
- Because of the stability of the boards and the shape of the end-match system no expansion gap is needed on the ends of the boards.

#### joist span

- The recommended joist span is 18" or 24" on center. If recovering an existing deck on 16" centers, MOSO® Bamboo X-treme® can be used with its structural end-match system.
- Because MOSO® Bamboo X-treme® is endmatched there is no need to have all joints join atop joists. End joints can meet or "fall between" the joists with 8" - 8" distance. If you wish a random pattern, the span should be reduced to 12".
- You should stagger your end joints so they do not line up from one row to the next.
- When decking installation is on an angle, or a random pattern is desired, the joist spacing should be 12" centers. Determine the final joist spacing only after talking with local building code officials.

#### installation with fasteners

- Determine the surface side of the boards (grooved or smooth surface).
- Use the MOSO® Asymmetric Fasteners in the following sequence:
  - Press fastener with hooked side in the groove of one board.
  - Pre-drill the joist screw holes 30 mm deep. On bamboo joists: use a 3.5 mm wide drill bit 110 mm long.
  - Fully tighten the screw. Always screw vertically to the joist. Apply low torque with slow screwing speed on the screwing machine. Perform some tests for correct torque and speed adjustment before full installation.
- Install every following board by sliding it under the waved side of the fasteners.
- When floating the joint between joists, putting a loose fastener on both sides of joint can help provide increased stability in the event that the joist move.
- Only use the included stainless steel decking screws (4.5 x 30 mm).
- Don't forget to make sure you float a fastener at the end-match when floating the joint. The fastener will provide added support and maintain proper spacing between the boards.
- Please watch the installation video ► [www.moso-bamboo.com/youtube/x-treme](http://www.moso-bamboo.com/youtube/x-treme)

#### number of fasteners needed per sqft

X-treme® width	on center		
	16"	18"	24"
96 mm	2.65	2.12	1.8
137 mm	1.85	1.48	1.11
178 mm	1.43	1.14	0.86

#### screw down installation

- Determine the surface side of the boards (grooved or smooth surface).
- Pre-drill the screw holes 3/4" from the side of the board. Be sure to predrill with a large enough drill (80% of screw diameter) to avoid cracking of the decking.
- We recommend using a countersink bit with a positive stop.
- Screws should be 305 grade stainless steel. Salt water contact may require 316 grade stainless steel, please consult local building codes.
- Always screw both sides (left and right in the width direction) of the board.
- Use at least a stainless steel quality decking screw with a minimum length of 1 5/8" for 1x6 decking.

#### best practices

- Don't forget to make sure that there is adequate airflow below the deck especially when installing in a low rise atmosphere. Even though the MOSO® Bamboo X-treme® can be installed closer to the ground than any other natural material, proper air flow is a separate issue and can have an adverse effect on the deck if not properly done.
- Don't forget to make sure you float a fastener at the end-match when floating the joint. The fastener will provide added support and maintain proper spacing between the boards. This applies to the decking as well as the siding.
- Don't forget to make sure that when installing the Bamboo X-treme® Siding vertically you put a mechanical fastener through the bottom of the board for extra support.
- If you want to maintain the unfinished look MOSO recommends cleaning the deck with the Messmer Deck cleaner and Brightener and apply a clear finish. This will keep the MOSO® Bamboo X-treme® in the best condition for its longest best life.
- When replacing the joists or building a new MOSO® Bamboo X-treme® Deck, it is best to use the joist material on 18" joist spacing.
- Carpenter Pencil makes the clearest most readable mark on MOSO® Bamboo X-treme®.

# MOSO® Bamboo X-treme® Outdoor Decking

## installation instructions

### cleaning and maintenance

- The MOSO® Bamboo X-treme® Outdoor Decking Board is a natural product, some variation in color, grain and appearance is normal. Color can change fast from dark brown to brown or grey, depending on the climatic conditions and maintenance schedule.
- Annual cleaning of your MOSO® Bamboo X-treme® Decking is recommended. Clean the deck using warm water, mild deck cleaner (Messmer Deck Cleaner and Messmer Brightener) and stiff bristle brush.
- After cleaning and drying, apply a coat of exterior finish (Messmer's MOSO® Bamboo Finish Oil).
- We recommend to repeat this (cleaning + applying a coat of exterior finish) at least once per year.
- See additional maintenance instructions at [www.moso-bamboo.com/youtube/minutes](http://www.moso-bamboo.com/youtube/minutes) (episode 22).

### storage and handling

MOSO® Bamboo X-treme® should be kept out of direct sunlight and should not be exposed to inclement weather before installation.

### additional note

While all due care is taken to ensure the accuracy of the installation instructions, individual circumstances (location, sub floor and installation procedures) may vary and are beyond the manufacturer's control. In case of doubt, please consult your local dealer/distributor. Always follow the local building code.

MOSO warrants the bamboo material and the mounting materials (fastener/screw) it supplies but does not warrant the connection with other materials (such as sub frame joist/battens). It is the responsibility of the installer to make sure the used screw matches such materials during the full lifetime of the product.

**These instructions are subject to change. For the latest version visit [www.moso-bamboo.com/x-treme/decking](http://www.moso-bamboo.com/x-treme/decking)**

Copyright © Nothing from this text may be reproduced without the prior permission in writing from MOSO North America Ltd., Inc.

EN-NA-2021-01



# MOSO® Bamboo X-treme® Outdoor Decking

## maintenance & cleaning

### maintenance

The surface of decking gets weathered under influence of wind, rain, frost and sunshine (UV). As a result, the surface turns grey, dirty and cracks/ splinters will appear. The best moment for initial maintenance is a few months (3-4) after installation because then the grains have opened up somewhat and allow a better absorption of the finish.

### maintenance of smooth surface

Please be aware of the fact that on the flat surface, irregularities in the surface (e.g. cracks, splinters) may be more visible than on the grooved surface. With regular maintenance with Messmer's MOSO® Bamboo Finish Oil, this will be reduced.



**Gradual greying of MOSO® Bamboo X-treme® over time:**

new, non-weathered decking



after 3 months of weathering



after 36 months of weathering

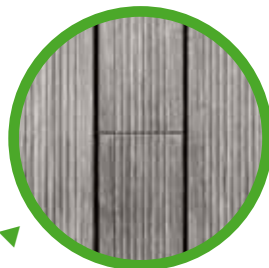

**Surface of MOSO® Bamboo X-treme® with different maintenance and cleaning scenarios:**

weathered, dirty decking



weathered, cleaned decking



refinished decking



### cleaning

- If you want to maintain the unfinished look MOSO recommends cleaning the deck with the Messmer Deck Cleaner and Messmer Brightener and apply a clear finish. This will keep the MOSO® Bamboo X-treme® in the best condition for its longest best life.
- Annual cleaning of your MOSO® Bamboo X-treme® Decking is recommended.
- Sweep with a broom or blow off with a leaf blower any loose debris first.
- Soak MOSO® Bamboo X-treme® with plenty of water. If possible use a garden hose. Do not use high-pressure cleaners.
- Clean the decking using warm water, mild deck cleaner and a non-metallic stiff bristle brush.
- Scrub the soaked material lengthwise following the bamboo grain until the material appears clean. If the decking has a smooth surface, first scrub under an angle of 45 degrees before scrubbing in the length direction. When using a machine disk this is not necessary. Repeat the cleaning if necessary. Clean the surface carefully with water.
- Leave MOSO® Bamboo X-treme® to dry for approx. 24 hours. The material must be completely dry before refinishing can be done.

### snow conditions

- You can use a soft bristle brush for snow. For heavier snows use a hard plastic snow shovel with rounded corners to prevent scratches to your deck. Never use a power piece of equipment to remove snow.
- Always shovel along the length of the boards never across.
- Never use rock salt or other de-icers. Use only products that are pet safe, urea free and salt free.

### application of exterior finish

- After you have purchased and installed our unfinished decking and choose to apply a finish, please let the deck boards acclimate to the environment 6-8 weeks. Please clean your deck with a deck cleaner (Messmer), allow to dry completely and apply your finish.
- Ask your dealer which brands of exterior finish are recommended. MOSO recommends: ► [www.messmers.com/messmers-uvplus-deck-stain](http://www.messmers.com/messmers-uvplus-deck-stain)
- Apply in dry weather only. Avoid direct sunlight and high temperatures.
- Follow all the manufacturer's instructions before applying the exterior finish. If you still have questions please call the customer service number provided.

WARRANTY  
**25**  
YEARS



**Beach club 'Klein Ockenburgh'**  
The Netherlands

**Private Residence**  
(16,000 sqft) Cancun, Mexico



# MOSO® Bamboo X-treme® Outdoor 2x2 Deck Tile

MOSO® Bamboo X-treme® 2x2 Deck Tile is a solid, Thermo-Density® decking tile, made from compressed bamboo strips. A special, heat-treatment process at 392°F (200°C) provides MOSO® Bamboo X-treme® the highest durability class possible in the appropriate European standard (see technical characteristics below) and increases the hardness and stability. These deck tiles are very suitable for commercial or residential rooftop terraces and plazas. Also on uneven surfaces (including cracked concrete patios) these tiles perform very well.

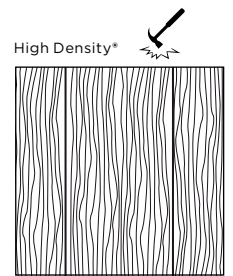

\*) Also on ends.

Unfinished	Edges*	Surface	Weight (lbs)	Size	Dimensions (")	Dimensions (mm)
BO-DKTL38-8S-UF	Macro Bevel	Smooth	23.1	2 x 2	1-1/2 x 23-7/8 x 23-7/8	38 x 606 x 606

## installation summary

- Install a suitable, fixed, stable and durable pedestal system. MOSO® Bamboo X-treme® Outdoor 2x2 Deck Tiles are not built for one specific pedestal manufacture. Please consult manufactures specification before installation.
- To make sure the tiles are always well leveled, place a biscuit/disc (in the corner notch of the tile) to connect the tile with the pedestal.
- The recommended maximum spacing for tile pedestals is 24" on center - please consult local building codes.
- Unfinished Bamboo X-treme® Deck Tiles can be left to weather naturally or can be finished 3-4 months after installation.
- Maintenance and cleaning: Routinely remove debris from your deck tiles such as leaves, grass clippings by sweeping (with a stiff bristle brush) or blowing them off. Power washing of the material is not recommended use only a regular hose and a stiff bristle brush to remove stuck on debris. In order to maintain its original color, you must coat the deck tiles 3-4 months after installation with a penetrating oil finish.
- For further info: please see the maintenance instructions.
- Store in a cool and dry place away from direct sunlight, and protected from weather influences, dirt and dust.

## technical characteristics and certifications

- Density: +/- 71.79 lbs/ft<sup>3</sup>
- Dimensional stability: length: + 0.1%; width + 0.9% (24 hours in water 68°F)
- Resistance to Indentation - Brinell Hardness: ≥ 1,350 psi (EN 1534)
- Reaction to fire: Class Bfl-s1 (EN 13501-1)
- Flame spread index: Flame spread 25, Smoke developed 45 Class A (ASTM E84) / CAN/ULC S102 (WUI approved)
- Slip resistance - new material: USRV 55 (Dry), USRV 29 (Wet), USRV 91 (Dry), USRV 42 (Wet) (Pendulum friction test - CEN/TS 16165 Annex C - CEN/TS 15676) / R 10 (Shod ramp test - CEN/TS 16165 Annex B - DIN 51130) / Class C (Barefoot ramp test - CEN/TS 16165 Annex A - DIN 51097)
- Slip resistance - weathered material: USRV 100 (Dry) (CEN/TS 16165 Annex C) / R 11 (CEN/TS 16165 Annex B - DIN 51130)
- Thermal emittance: 0.81 (ASTM C1371)<sup>1)</sup>
- Solar Reflectance (SR): 0.32 (ASTM C1549)<sup>1)</sup>
- Solar Reflectance Index (SRI): Low 27, Medium 30, High 33 (ASTM E1980)<sup>1)</sup>
- Modulus of Elasticity: 13565 MPa (EN 408, equivalent ASTM D 198)
- Bending strength: 54.4 MPa (EN 408, equivalent ASTM D 198)
- Biological durability: Class 1 (EN 350 / CEN/TS 15083-2), simulated graveyard test / Class 1 (EN 350 / CEN/TS 15083-1)
- Effectiveness against Blue Stain: Class 0 (EN 152)
- Use Class: Class 4 (EN 335)
- CO<sub>2</sub> neutral: LCA report TU Delft (ISO 14040/44) ([www.moso-bamboo.com/lca](http://www.moso-bamboo.com/lca))
- Environmental Product Declaration - EPD (EN 15804) ([www.moso-bamboo.com/epd](http://www.moso-bamboo.com/epd))
- FSC®: Products available with FSC® certification on request.
- Contribution LEED BD+C - v4: MR 1, MR 2, EQ 2, SS 7 v2009: MR 6, MR 7 (FSC®), IEQ 4.3, IEQ 4.4
- Contribution BREEAM: MAT 1, MAT 5 (HD)
- Warranty: 25 years

<sup>1)</sup> Tested on 3 years weathered MOSO® Bamboo X-treme®.



breeam



**Private Residence** United States of America

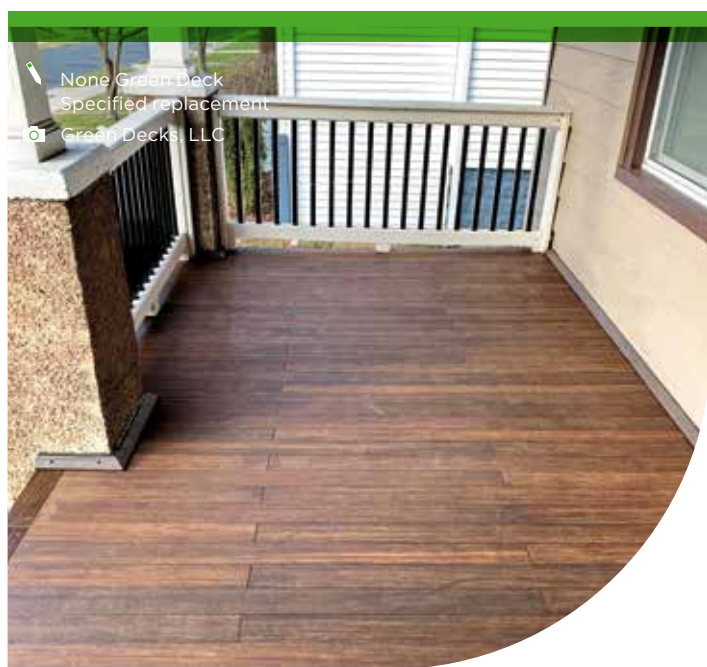

**Private Residence**  
(250 sqft) Collingswood, New Jersey, United States of America

**Private Residence**  
United States of America



# MOSO® Bamboo X-treme® 1x4 T&G

MOSO® Bamboo X-treme® 1x4 T&G is a solid, Thermo-Density® board, made from compressed bamboo strips. A special, heat-treatment process at 392°F (200°C) provides MOSO® Bamboo X-treme® the highest durability class possible in the appropriate European standard (see technical characteristics below) and increases the hardness and stability. These floor boards are very suitable for covered outdoor areas. They come unfinished and thanks to the tongue and groove system the installation is fast and easy. MOSO® Bamboo X-treme® 1x4 T&G can be used for porch flooring, covered ceilings and soffits.

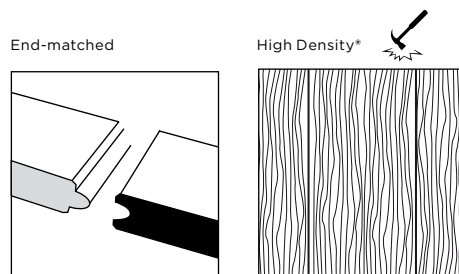

\*) Also on ends.

Unfinished	Grooved	Edges*	Surface	End-matched	Size	Dimensions (")	Dimensions (mm)
BO-POR-18-96-UF	Yes	Macro Bevel	Smooth	Yes	1 x 4 x 6	3/4 x 3 7/8 x 72	18 x 96 x 1830

## installation summary

- Install a suitable, fixed, stable and durable joist system.
- The recommended maximum span for 18 mm is 12" on center - but your local building codes may be less.
- Each porch board must be installed flush and tight against the joist system with a fastener insert through the tongue and into the joist.
- Fasteners should be attached at 45 degrees from vertical into the groove on the tongue and into the porch board and joist below. Fasteners should be no larger than 18 gauge flooring cleats.
- The first board and final boards should be face screwed to the joist system using stainless steel screws, predrilled and countersunk.
- Use a 1-2% slope and ensure good ventilation.
- Unfinished Bamboo X-treme® decking can be left to weather naturally or can be finished 3-4 months after installation.
- When not applying outdoor oil regularly, the deck will acquire a grey color tone and the typical bamboo grain structure will become less visible.
- Maintenance and cleaning: Routinely remove debris from your porch flooring such as leaves, grass clippings by sweeping (with a stiff bristle brush) or blowing them off. Power washing of the material is not recommended use only a regular hose and a stiff bristle brush to remove stuck on debris.
- For further info: please see the maintenance instructions.
- Store in a cool and dry place away from direct sunlight, and protected from weather influences, dirt and dust.
- Full version available at ► [www.moso-bamboo.com/x-treme/porch-flooring](http://www.moso-bamboo.com/x-treme/porch-flooring)

## technical characteristics and certifications

- Density: +/- 71.79 lbs/ft³
- Dimensional stability:  
length: + 0.1%; width + 0.9% (24 hours in water 68°F)
- Resistance to Indentation - Brinell Hardness: ≥ 1,350 psi (EN 1534)
- Reaction to fire: Class Bfl-s1 (EN 13501-1)
- Flame spread index: Flame spread 25, Smoke developed 45  
Class A (ASTM E84) / CAN/ULC S102 (WUI approved)
- Slip resistance - new material: USRV 55 (Dry), USRV 29 (Wet), USRV 91 (Dry),  
USRV 42 (Wet) (Pendulum friction test - CEN/TS 16165 Annex C - CEN/TS 15676) /  
R 10 (Shod ramp test - CEN/TS 16165 Annex B - DIN 51130) / Class C (Barefoot ramp test -  
CEN/TS 16165 Annex A - DIN 51097)
- Slip resistance - weathered material: USRV 100 (Dry) (CEN/TS 16165 Annex C) /  
R 11 (CEN/TS 16165 Annex B - DIN 51130)
- Thermal emittance: 0.81 (ASTM C1371)<sup>1)</sup>
- Solar Reflectance (SR): 0.32 (ASTM C1549)<sup>1)</sup>
- Solar Reflectance Index (SRI): Low 27, Medium 30, High 33 (ASTM E1980)<sup>1)</sup>
- Modulus of Elasticity: 13565 MPa (EN 408, equivalent ASTM D 198)
- Bending strength: 54.4 MPa (EN 408, equivalent ASTM D 198)
- Biological durability: Class 1 (EN 350 / CEN/TS 15083-2), simulated graveyard test /  
Class 1 (EN 350 / CEN/TS 15083-1)
- Effectiveness against Blue Stain: Class 0 (EN 152)
- Use Class: Class 4 (EN 335)
- CO<sub>2</sub> neutral: LCA report TU Delft (ISO 14040/44) ([www.moso-bamboo.com/lca](http://www.moso-bamboo.com/lca))
- Environmental Product Declaration - EPD (EN 15804) ([www.moso-bamboo.com/epd](http://www.moso-bamboo.com/epd))
- FSC®: Products available with FSC® certification on request.
- Contribution LEED BD+C - v4: MR 1, MR 2, MR 3 (FSC®), EQ 2, SS 7  
v2009: MR 6, MR 7 (FSC®), IEQ 4.3, IEQ 4.4
- Contribution BREEAM: MAT 1, MAT 3 (FSC®), MAT 5 (HD)
- Warranty: 25 years

<sup>1)</sup> Tested on 3 years weathered MOSO® Bamboo X-treme®.

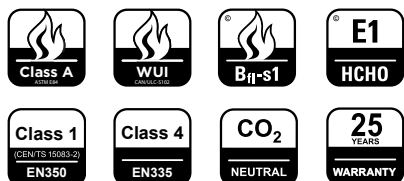

Only available on special request.



The mark of responsible forestry  
FSC® C002063



breeam

# MOSO® Bamboo X-treme® 1x4 T&G

## installation instructions

### before installation

- Local building codes must always be consulted when building an exterior deck. Most counties require building permits.
- Water logging under the flooring must be avoided by preparing a water permeable ground structure. This can be achieved by sand layers and gravel dispersion above.
- Install the floor boards with a slope of 1-2% to enable water to run off the surface.
- There must be adequate air circulation underneath the floor to prevent cupping and warping of the boards.
- When the surface underneath the flooring is not fast drying, there should be at least 4" distance between the floor and the surface underneath the floor.
- In applications where the floor is being built closer to wet ground, a vapor barrier is recommended to prevent water from absorbing into the underside of the material.

### safety

Drilling, sawing, sanding, and machining MOSO® Bamboo X-treme® generates dust. Avoid inhaling dust by wearing a dust mask. Contact MOSO® for MSDS information.

### required tools

- Powernail 50P 18 GA. cleat nailer
- Rubber mallet (comes with the nailer)
- 1 3/4" 18 GA. flooring cleats (DO NOT USE 16 GA.) available from Powernail (L175185) and Grip-Rite (GRFLN175)
- Drill
- Drill bits
- Safety glasses
- Bamboo X-treme® can be crosscut with a quality chop saw, using a (40 tooth) carbide-tipped blade. Ripping can be done on a standard table saw, using a properly aligned quality fence with a carbide-tipped blade.
- Bamboo X-treme® can be routed or planed with high-speed steel or carbide cutters. When required, only sand in the direction of the grain - i.e. belt sander. Never use an orbital sander.

### the installation

#### spacing

- Spacing between the house and product is recommended. An 1/4" gap is recommended. When fastening the material to the joists it is not necessary to pound the boards together but rather snug the board to the previous one while checking for run out as you move across the floor. The flooring should be installed directly to the joists and not to plywood
- Because of the stability of the boards and the shape of the end-match system no expansion gap is needed on the ends of the boards.
- Every cut end has to be treated with board end sealer, to prevent water penetration.

#### joist span

- The recommended maximum span is 12" on center - but your local building codes may be less.
- End joints should meet on top of the joists and be properly supported.
- For best appearance and strength, end joints should be staggered to prevent direct alignment of the ends.
- In case the end joints don't meet perfectly atop the joist, sistering blocks can be installed on the joists, to allow for room for the cleat.
- When the floor installation is on an angle, the joist spacing must maintain the 12" centers and cover four joists. Determine the final joist spacing only after talking with local building code officials. MOSO will not be responsible for an insufficient load bearing structural design.

#### installation with hidden fasteners

- We recommend using the Powernailer 50P 18-gauge cleat nailer which is widely available as the choice of flooring professionals. Use only 18 gauge cleats as noted above.
- Each floor board must be installed flush and tight against the joist system with a fastener insert through the tongue and into the joist. Ensure joists are properly aligned on the top; use shims to if necessary.
- Fasteners should be attached at 45 degrees from vertical into the end-match system and into the board and joist below. Test the gun using a scrap piece of flooring to ensure that the bottom plate/foot of the nailer is properly positioned so the fastener is installed in the correct place and angle.
- Installers should adjust the pressure to ensure the fastener is placed just below the surface (generally 80 to 90 psi no greater). A setting tool or punch is handy to drive fasteners below the surface if needed.
- Always apply firm pressure to the nailer by holding it in contact with the material, centered over the joist and stabilizing it at a 90-degree angle to the flooring. The nailer will insert the cleat at a 45-degree angle seating the flooring directly to the joist. Be careful when attaching fasteners close to edge to avoid splitting the end-match system.
- The first board and final boards should be face screwed to the joist system using stainless steel screws, predrilled and countersunk. For concealing the screws use a common plugging system available in the market.

#### screw down installation

- Pre-drill the screw holes 3/4" from the side of the board. Be sure to predrill with a large enough drill (80% of screw diameter) to avoid cracking of the floor.
- We recommend using a countersink bit with a positive stop.
- Screws should be 305 grade stainless steel (salt water contact may require 316 grade stainless steel, please consult local building codes).
- Always screw both sides (left and right in the width direction) of the board.
- Use at least stainless steel quality decking screws.

### cleaning and maintenance

- The MOSO® Bamboo X-treme® Board is a natural product, some variation in color, grain and appearance is normal. Color can change fast from dark brown to brown or grey, depending on the climatic conditions and maintenance schedule.
- Annual cleaning of your MOSO® Bamboo X-treme® Decking is recommended. Clean the deck using warm water, mild deck cleaner (Messmer Deck Cleaner and Messmer Brightener) and stiff bristle brush.
- After cleaning and drying, apply a coat of exterior finish (Messmer's MOSO® Bamboo Finish Oil).
- We recommend to repeat this (cleaning + applying a coat of exterior finish) at least once per year.
- See additional maintenance instructions at [www.moso-bamboo.com/youtube/minutes](http://www.moso-bamboo.com/youtube/minutes) (episode 22).

### storage and handling

MOSO® Bamboo X-treme® should be kept out of direct sunlight and should not be exposed to inclement weather before installation.

### additional note

While all due care is taken to ensure the accuracy of the installation instructions, individual circumstances (location, sub floor and installation procedures) may vary and are beyond the manufacturer's control. In case of doubt, please consult your local dealer/distributor. Always follow the local building code.

**These instructions are subject to change. For the latest version visit [www.moso-bamboo.com/x-treme/decking](http://www.moso-bamboo.com/x-treme/decking)**

Copyright © Nothing from this text may be reproduced without the prior permission in writing from MOSO North America Ltd., Inc.



# MOSO® Bamboo X-treme® Soffit, Trim & Fascia Boards

MOSO® Bamboo X-treme® Soffit, Trim and Fascia Boards are solid, Thermo-Density® boards, made from compressed bamboo strips. A special, heat-treatment process at 392°F (200°C) provides MOSO® Bamboo X-treme® the highest durability class possible in the appropriate European standard (see technical characteristics below) and increases the hardness and stability. MOSO® Bamboo X-treme® Soffit, Trim and Fascia Boards provide the final accents of your deck or siding projects. The Bamboo X-treme® Boards also present a more stable and sustainable option compared to more expensive PVC.

1 x 4 x 6  
Board unfinished  
Eased Edge



1 x 8 x 6  
Board unfinished  
Square Edge

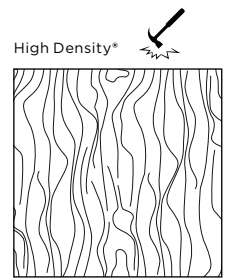

\*) Also on ends.

Unfinished	Material	Edges*	Surface	Size	Dimensions (")	Dimensions (mm)
BO-DK20-GO-96UF	Thermo Density® bamboo	Eased Edge	Smooth	1 x 4 x 6	3/4 x 3 7/8 x 72	20 x 96 x 1830
BO-LUM20-205	Thermo Density® bamboo	Square Edge	Smooth	1 x 8 x 6	3/4 x 8 x 73 1/4	20 x 205 x 1860
BO-LUM20-305	Thermo Density® bamboo	Square Edge	Smooth	1 x 12 x 6	3/4 x 12 x 73-1/4	20 x 305 x 1860
BO-LUM40-152	Thermo Density® bamboo	Square Edge	Smooth	2 x 6 x 6	1 1/2 x 6 x 73 1/4	40 x 152 x 1860

## technical characteristics and certifications

- Density: +/- 71.79 lbs/ft<sup>3</sup>
- Dimensional stability:  
length: + 0.1%; width + 0.9% (24 hours in water 68°F)
- Resistance to Indentation - Brinell Hardness: ≥ 65.5 psi (EN 1534)
- Reaction to fire: Class B-s1-d0 (EN 13501-1)<sup>1)</sup>
- Flame spread index: Flame spread 25, Smoke developed 45  
Class A (ASTM E84) / CAN/ULC S102 (WUI approved)
- Thermal emittance: 0.81 (ASTM C1371)<sup>2)</sup>
- Solar Reflectance (SR): 0.32 (ASTM C1549)<sup>2)</sup>
- Solar Reflectance Index (SRI): Low 27, Medium 30, High 33 (ASTM E1980)<sup>2)</sup>
- Modulus of Elasticity: 13565 MPa (EN 408, equivalent ASTM D 198)
- Bending strength: 54.4 MPa (EN 408, equivalent ASTM D 198)
- Biological durability: Class 1 (EN 350 / CEN/TS 15083-2), simulated graveyard test / Class 1 (EN 350 / CEN/TS 15083-1)
- Effectiveness against Blue Stain: Class 0 (EN 152)
- Use Class: Class 4 (EN 335)
- CO<sub>2</sub> neutral: LCA report TU Delft (ISO 14040/44) ([www.moso-bamboo.com/lca](http://www.moso-bamboo.com/lca))
- Environmental Product Declaration - EPD (EN 15804) ([www.moso-bamboo.com/epd](http://www.moso-bamboo.com/epd))
- FSC®: Products available with FSC® certification on request.
- Contribution LEED BD+C - v4: MR 1, MR 2, MR 3 (FSC®), EQ 2, SS 7 v2009: MR 6, MR 7 (FSC®)
- Contribution BREEAM: MAT 1, MAT 3 (FSC®), MAT 5 (HD)
- Warranty: 25 years

<sup>1)</sup> Tested on 18 mm thickness, without gaps between boards, with ventilation space behind boards.  
<sup>2)</sup> Tested on 3 years weathered MOSO® Bamboo X-treme®.

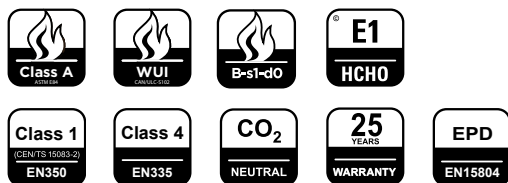

Only available on special request.



The mark of responsible forestry  
FSC® C002063



breeam



Adam Bacher Photography

**Union Station** (8,000 sqft) Vancouver, United States of America



John Leonfflu

**Private Residence Del Mar**  
(2,474 sqft) California, United States of America

**Private Residence Kjeller**  
Kjeller, Norway



Hover Imagery

# MOSO® Bamboo X-treme® Outdoor Siding

MOSO® Bamboo X-treme® siding is a solid, Thermo-Density® exterior board, made from compressed bamboo strips. A special, heat-treatment process at 392°F (200°C) provides MOSO® Bamboo X-treme® the highest durability class possible in the appropriate European standard, increases the stability and density, and consequently the hardness. Furthermore, contrary to other wood products, this product achieves fire resistance Class A (ASTM E84) without impregnation with expensive and eco-damaging fire retardants. MOSO® Bamboo X-treme® siding is available as a shiplap profile and can be installed with fasteners or screws. Bamboo X-treme® will weather over time to a silver patina.

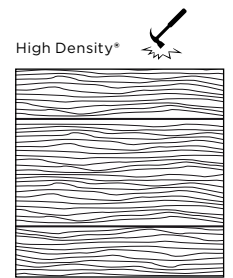
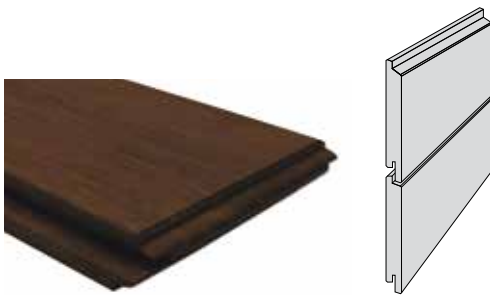

\*) Also on ends.

Unfinished	Edges*	Surface	End-matched	Size	Dimensions (**)	Actual width (mm)	Dimensions (mm)
BO-SID18-137	Macro Bevel	Smooth	Yes	1 x 6 x 6	3/4 X 5-3/8 X 73	128	18 x 137 x 1850
BO-SID18-178	Macro Bevel	Smooth	Yes	1 x 8 x 6	3/4 x 7 x 73	173	18 x 178 x 1850

## installation summary

- Apply a waterproof membrane to the wall and screw vertical battens onto that.
- Each board should be fixed on at least 3 battens: so the maximum centre-to-centre distance between the battens / beams is 24".
- Install the first, bottom, row of fasteners on the battens and place the first row of boards onto them.
- Place the second row of fasteners/boards and continue like this with the whole surface.
- Don't forget to make sure you float a fastener at the end-match when floating the joint. The fastener will provide added support and maintain proper spacing between the boards.
- Don't forget to make sure that when installing the Bamboo X-treme® Siding vertically you put a mechanical fastener through the bottom of the board for extra support.
- For further info: please see the installation / maintenance instructions.
- MOSO warrants the bamboo material and the mounting materials (fastener/screw) it supplies but does not warrant the connection with other materials (such as sub frame joists/battens). It is the responsibility of the installer to make sure the used screw matches such materials during the full lifetime of the product.
- Store in a cool and dry place away from direct sunlight, and protected from weather influences, dirt and dust.
- Full version available at ▶ [www.moso-bamboo.com/x-treme/siding](http://www.moso-bamboo.com/x-treme/siding)

## technical characteristics and certifications

- Density: +/- 71.79 lbs/ft<sup>3</sup>
- Dimensional stability:  
length: + 0.1%; width + 0.9% (24 hours in water 68°F)
- Resistance to Indentation - Brinell Hardness: ≥ 65.5 psi (EN 1534)
- Reaction to fire: Class B-s1-d0 (EN 13501-1)<sup>1)</sup>
- Flame spread index: Flame spread 25, Smoke developed 45  
Class A (ASTM E84) / CAN/ULC S102 (WUI approved)
- Thermal emittance: 0.81 (ASTM C1371)<sup>2)</sup>
- Solar Reflectance (SR): 0.32 (ASTM C1549)<sup>2)</sup>
- Solar Reflectance Index (SRI): Low 27, Medium 30, High 33 (ASTM E1980)<sup>2)</sup>
- Modulus of Elasticity: 13565 MPa (EN 408, equivalent ASTM D 198)
- Bending strength: 54.4 MPa (EN 408, equivalent ASTM D 198)
- Biological durability: Class 1 (EN 350 / CEN/TS 15083-2), simulated graveyard test / Class 1 (EN 350 / CEN/TS 15083-1)
- Effectiveness against Blue Stain: Class 0 (EN 152)
- Use Class: Class 4 (EN 335)
- CO<sub>2</sub> neutral: LCA report TU Delft (ISO 14040/44) ([www.moso-bamboo.com/lca](http://www.moso-bamboo.com/lca))
- Environmental Product Declaration - EPD (EN 15804) ([www.moso-bamboo.com/epd](http://www.moso-bamboo.com/epd))
- FSC®: Products available with FSC® certification on request.
- Contribution LEED BD+C - v4: MR 1, MR 2, MR 3 (FSC®), EQ 2, SS 7  
v2009: MR 6, MR 7 (FSC®)
- Contribution BREEAM: MAT 1, MAT 3 (FSC®), MAT 5 (HD)
- Warranty: 25 years

<sup>1)</sup> Tested on 18 mm thickness, without gaps between boards, with ventilation space behind boards.  
<sup>2)</sup> Tested on 3 years weathered MOSO® Bamboo X-treme®.

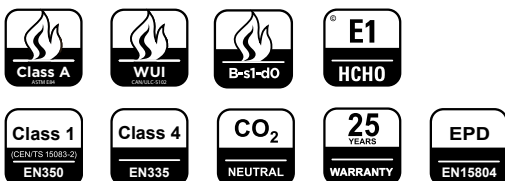

Only available on special request.



The mark of responsible forestry  
FSC® C002063



breeam

# MOSO® Bamboo X-treme® Outdoor Siding

## installation instructions

### storage and handling

Store in a cool and dry place away from direct sunlight, and protected from weather influences, dirt and dust.

### safety

Drilling, sawing, sanding, and machining Bamboo X-treme® generates dust. Avoid inhaling dust by wearing a dust mask. Visit [www.moso-bamboo.com](http://www.moso-bamboo.com) for MSDS information.

### please note

- Local building codes must always be consulted. Most countries require building permits.
- MOSO® Bamboo X-treme® is a natural product, which varies in color, grain and appearance. Color can change fast from dark brown to brown or gray, depending on the maintenance schedule.

### required tools

- Drill
- Drill bits
- A four foot and eight-foot level
- Safety glasses
- Power screw gun with ratcheting torque setting
- Chop saw
- Bamboo X-treme® can be crosscut with a quality chop saw, using a carbide-tipped blade. Ripping can be done on a standard table saw, using a properly aligned quality fence with a carbide-tipped blade.
- Anchorseal-2 Wood Sealer or equivalent is strongly recommended on cross-cut ends to minimize the effects of weather on these exposed ends.
- Bamboo X-treme® can be routed or planed with high-speed steel or carbide cutters. When required, only sand in the direction of the grain—i.e. belt sander. Never use an orbital sander.

### before installation

- Bamboo X-treme® Siding should not be installed in contact with the ground at grade level, a concrete slab, deck materials or standing water. Allow a minimum of 1" - 2" clearance between the bottom edges of the rain screen and the ground, slab, or deck to allow for adequate ventilation.
- Each board should be fixed on at least 3 battens so the maximum centre-to-centre distance in between is 2 ft (616.7 mm / 24") (diagram 1 - random pattern).
- Keep at least 3/16" ventilation space between the boards (in vertical direction). Installation with MOSO® Asymmetric Fasteners ensures correct spacing automatically.
- Because of the stability of the boards and the shape of the end-match system no expansion space is needed on the length (board ends).
- We recommend applying end sealer on every cut end to prevent water penetration. Failure to end seal the boards at the time of installation may lead to checking which is not covered by the warranty.
- At the edges of the siding, keep a distance of 1/4" - 1/2" from adjacent materials, to allow for sufficient ventilation.
- If a random joint pattern is desired, the distance between the battens should be maximum 300 mm / 12" (diagram 2 - random pattern).

diagram 1 - normal pattern

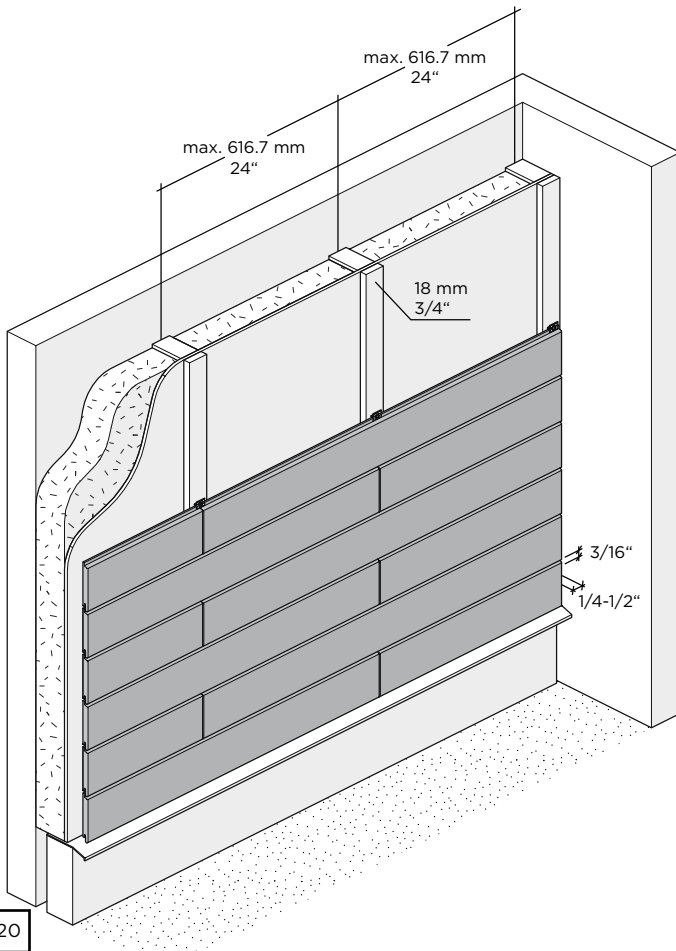
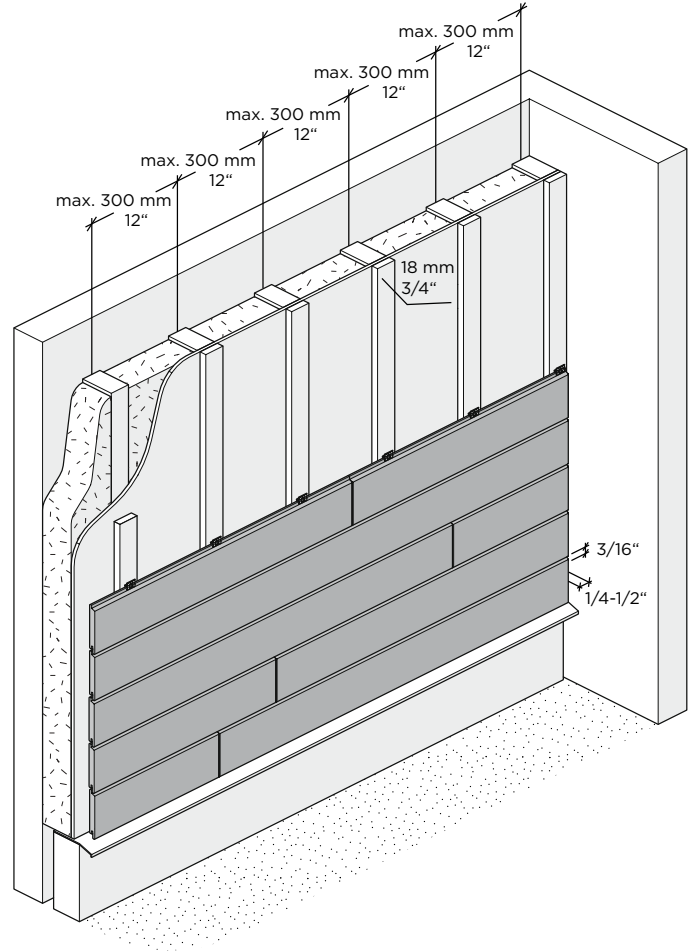

diagram 2 - random pattern



# MOSO® Bamboo X-treme® Outdoor Siding

## installation instructions

### the installation

- Apply a waterproof membrane against the wall and screw vertical battens (at least 3/8" thick x 1-7/8" wide / 1x2" (19 mm thick x 60 mm wide) onto that, creating a rigid / flat surface onto which the boards can be fixed.
- The siding boards should be fixed using the MOSO® Asymmetric Fasteners (CLIPSCREW-BX08). Use a screw that is suitable for the material of the chosen batten.
- Make sure the MOSO® Asymmetric Fasteners are screwed in the middle of the batten so that it is fully supported.

#### STEP 1 - leveling fasteners

- Start with the lowest row of fasteners (MOSO® Asymmetric Fastener with waved side up) and make sure they are placed fully level (using a spirit level).
- Avoid overtightening the screws as this can pull the fastener slightly into the wood, making it difficult to place the board onto the fastener.

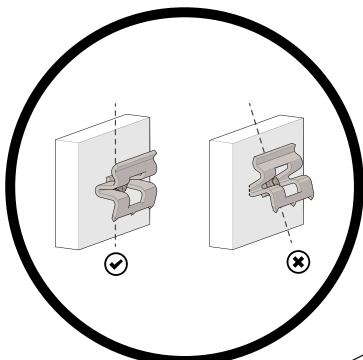

#### STEP 2 - install first row of boards

- Place the board onto the row of fasteners. The waved side of the fastener enables an easy grip into the groove of the board.
- Make sure that the fasteners engage deeply enough in the groove so that the boards lay level. Tapping the boards should be done carefully, preferably with a rubber mallet.
- We recommend fixing the end of the boards (end joints) on a batten, using 2 fasteners; one fastener for the ends, top and bottom, will suffice for fastening the end-matched ends of the boards.
- Make sure you keep a ventilation gap (1/4" - 1/2") on the edge of the cladding.
- Install the first row of boards.

#### STEP 3 - install second row

- Install the second row of fasteners (MOSO® Asymmetric Fastener with waved side up), pushing them down on the tongue of the first row of boards.
- Install the second row of boards in the same way, and continue for the rest of the surface.
- Check regularly if the boards are level.

#### STEP 4 Continue with the rest

- Continue to install the cladding boards in this way to cover the full surface.

### cleaning and maintenance

The surface sides of the boards will get rougher and silver over time. If you want to keep a darker color, regular maintenance is needed:

- Clean the material with water.
- Let the material dry.
- Apply a coat of exterior penetrating oil for hardwoods.
- We recommend to repeat this (cleaning + reapplying oil) at least once per year.
- See additional maintenance instructions at [www.moso-bamboo.com/x-treme](http://www.moso-bamboo.com/x-treme)

### additional note

While all due care is taken to ensure the accuracy of the installation instructions, individual circumstances (location, wall structure/sheathing and installation procedures) may vary and are beyond the manufacturer's control. In case of doubt, please consult your local dealer/distributor. Always follow the local building code. MOSO warrants the bamboo material and the mounting materials (fastener/screw) it supplies but does not warrant the connection with other materials (such as sub frame joist/battens). It is the responsibility of the installer to make sure the used screw matches such materials during the full lifetime of the product.

**These instructions are subject to change. For the latest version visit [www.moso-bamboo.com/x-treme/siding](http://www.moso-bamboo.com/x-treme/siding)**  
 Copyright © Nothing from this text may be reproduced without the prior permission in writing from MOSO North America Ltd., Inc.

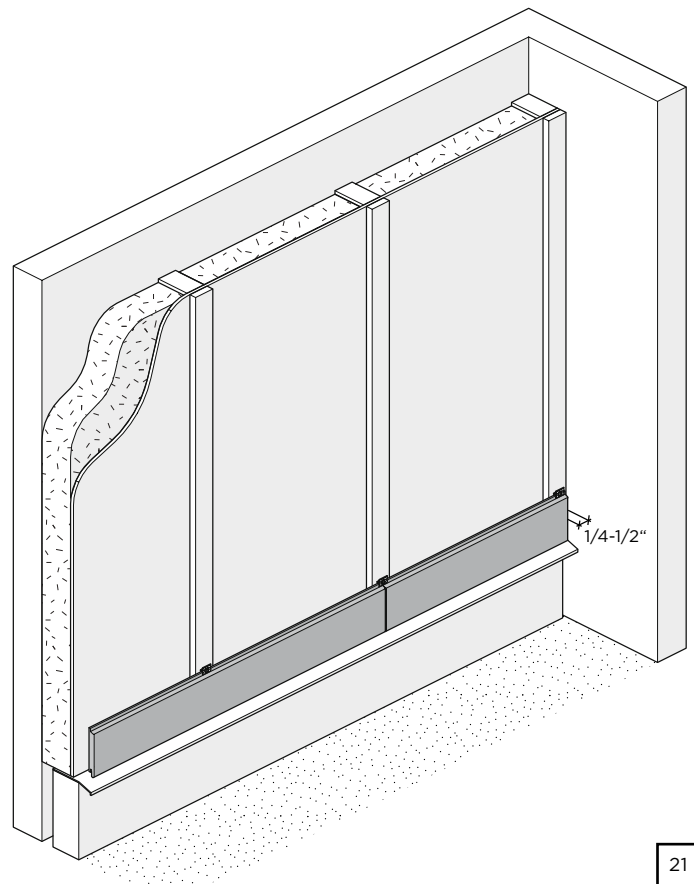
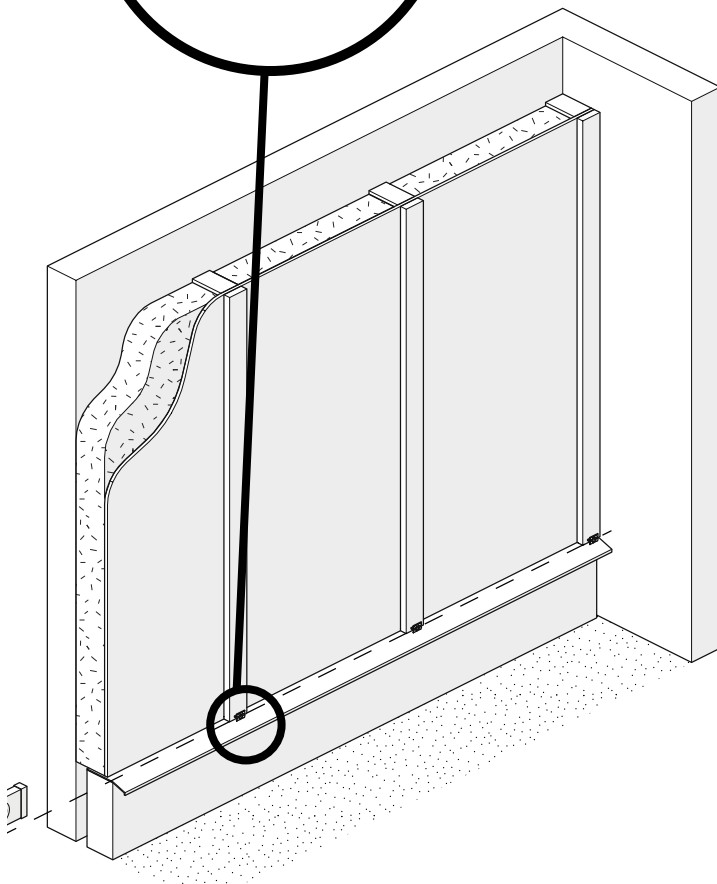

WARRANTY  
**25**  
YEARS



MOSO®

**MOSO Office** (377 sqft) Barcelona, Spain



Santos Moreira architect  
Pedro Machado

**Private Residence Paços de Ferreira**  
(808 sqft) Paços de Ferreira, Portugal

**The Versailles Apartment Complex**  
(4,500 sqft) Philadelphia, United States of America

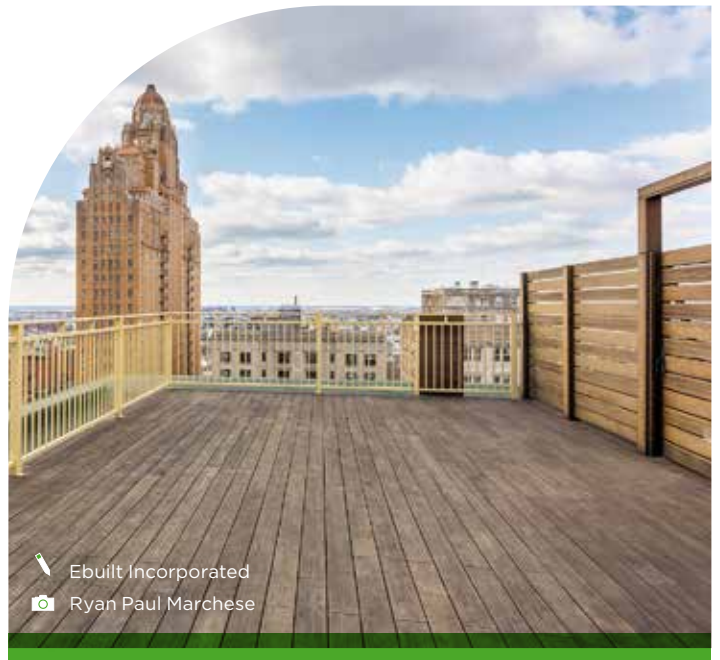

Ebuilt Incorporated  
Ryan Paul Marchese

# MOSO® Bamboo X-treme® Fencing

MOSO® Bamboo X-treme® fence boards are solid, Thermo-Density® exterior boards, made from compressed bamboo strips. A special, unique heat-treatment process at 392°F (200°C) provides MOSO® Bamboo X-treme® with the highest durability class possible in the appropriate European standards and increases the hardness and stability. The fence boards, equipped with a tongue/groove connection, are mounted between posts with U-profiles (not provided by MOSO®). Like any untreated tropical hardwood species, when exposed to outdoor conditions, MOSO® Bamboo X-treme® will turn grey over time creating a very natural look.



\*) Also on ends.

Unfinished	Grooved	Edges*	Surface	End-matched	Effective width (mm)	Size	Dimensions (")	Dimensions (mm)
BO-DTHT302TG-UF	Yes	Macro Bevel	Smooth	No	131	1 x 6	3/4 x 5 3/8 x 72	20 x 137 x 1830

## technical characteristics and certifications

- Density: +/- 71.79 lbs/ft<sup>3</sup>
- Dimensional stability:  
length: + 0.1%; width + 0.9% (24 hours in water 68°F)
- Resistance to Indentation - Brinell Hardness: ≥ 65.5 psi (EN 1534)
- Reaction to fire: Class B-s1-d0 (EN 13501-1)<sup>1)</sup>
- Flame spread index: Flame spread 25, Smoke developed 45  
Class A (ASTM E84) / CAN/ULC S102 (WUI approved)
- Thermal emittance: 0.81 (ASTM C1371)<sup>2)</sup>
- Solar Reflectance (SR): 0.32 (ASTM C1549)<sup>2)</sup>
- Solar Reflectance Index (SRI): Low 27, Medium 30, High 33 (ASTM E1980)<sup>2)</sup>
- Modulus of Elasticity: 13565 MPa (EN 408, equivalent ASTM D 198)
- Bending strength: 54.4 MPa (EN 408, equivalent ASTM D 198)
- Biological durability: Class 1 (EN 350 / CEN/TS 15083-2), simulated graveyard test / Class 1 (EN 350 / CEN/TS 15083-1)
- Effectiveness against Blue Stain: Class 0 (EN 152)
- Use Class: Class 4 (EN 335)
- CO<sub>2</sub> neutral: LCA report TU Delft (ISO 14040/44) ([www.moso-bamboo.com/lca](http://www.moso-bamboo.com/lca))
- Environmental Product Declaration - EPD (EN 15804) ([www.moso-bamboo.com/epd](http://www.moso-bamboo.com/epd))
- FSC®: Products available with FSC® certification on request.
- Contribution LEED BD+C - v4: MR 1, MR 2, MR 3 (FSC®), EQ 2, SS 7 v2009: MR 6, MR 7 (FSC®)
- Contribution BREEAM: MAT 1, MAT 3 (FSC®), MAT 5 (HD)
- Warranty: 25 years

<sup>1)</sup> Tested on 18 mm thickness, without gaps between boards, with ventilation space behind boards.  
<sup>2)</sup> Tested on 3 years weathered MOSO® Bamboo X-treme®.

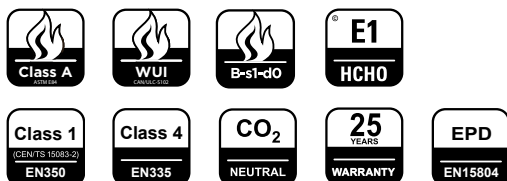

Only available on special request.



The mark of responsible forestry  
FSC® C002063



breeam



 SPEE Architects  
 Awood  
 Ossip van Duivenbode

**SPEEHOUSE** (32,808 sqft) The Netherlands

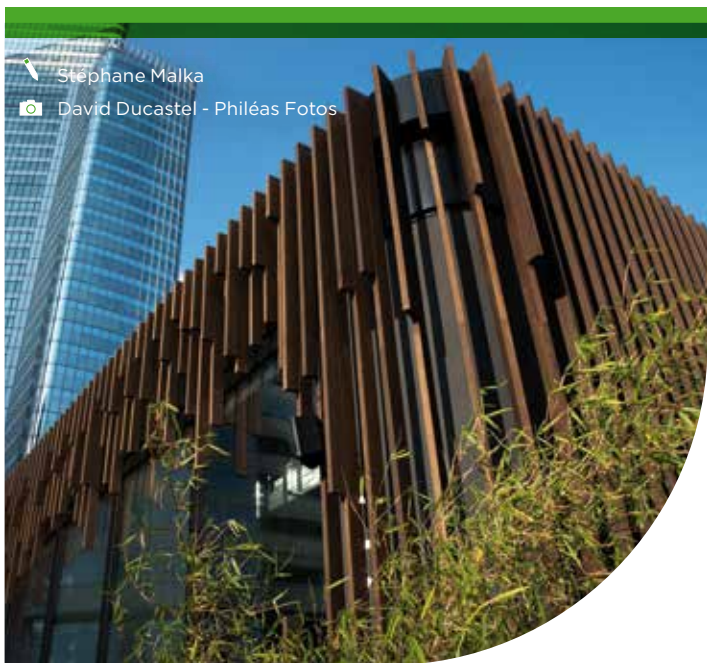

 Stéphane Malka  
 David Ducastel - Philéas Fotos

**Oxygen event complex**  
(18,000 lf) La Défense Paris, France

**Renovation City Centre Leverkusen**  
(8,611 lf) Leverkusen, Germany



 VETZ  
 MOSO\*



# MOSO® Bamboo X-treme® 2x Beams

MOSO® Bamboo X-treme® 2x is a solid, Thermo-Density® beam, made from compressed bamboo strips. A special, heat-treatment process at 392°F (200°C) provides MOSO® Bamboo X-treme® the highest durability class possible in the appropriate European standard (see technical characteristics below) and increases the hardness and stability. These products are used in a variety of applications such as outdoor furniture and vertical facade systems.

**BO-DTHT2173-2**  
2 x 2  
1 1/2 x 1 1/2 x 79"



**BO-DTHT2175-2**  
2 x 4  
1 1/2 x 3 1/2 x 79"

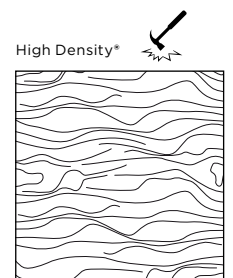

Unfinished	Profile	Size	Dimensions (")	Dimensions (mm)
BO-DTHT2173-2	S4S E4E	2 x 2	1 1/2 x 1 1/2 x 79	40 x 40 x 2000
BO-DTHT2175-2	S4S E4E	2 x 4	1 1/2 x 3 1/2 x 79	40 x 90 x 2000

## technical characteristics and certifications

- Density: +/- 71.79 lbs/ft<sup>3</sup>
- Dimensional stability:  
length: + 0.1%; width: + 0.9% (24 hours in water 68°F)
- Resistance to Indentation - Brinell Hardness: ≥ 65.5 psi (EN 1534)
- Reaction to fire: Class B-s1-d0 (EN 13501-1)<sup>1)</sup>
- Flame spread index: Flame spread 25, Smoke developed 45  
Class A (ASTM E84) / CAN/ULC S102 (WUI approved)
- Thermal emittance: 0.81 (ASTM C1371)<sup>2)</sup>
- Solar Reflectance (SR): 0.32 (ASTM C1549)<sup>2)</sup>
- Solar Reflectance Index (SRI): Low 27, Medium 30, High 33 (ASTM E1980)<sup>2)</sup>
- Modulus of Elasticity: 13656 MPa (EN 408, equivalent ASTM D 198)
- Breaking strength: 54.4 MPa (EN 408, equivalent ASTM D 198)
- Biological durability: Class 1 (EN 350 / CEN/TS 15083-2), simulated graveyard test / Class 1 (EN 350 / CEN/TS 15083-1)
- Effectiveness against Blue Stain: Class 0 (EN 152)
- Use Class: Class 4 (EN 335)
- CO2 neutral: LCA report TU Delft (ISO 14040/44) ([www.moso.eu/lca](http://www.moso.eu/lca))
- Environmental Product Declaration - EPD (EN 15804) ([www.moso.eu/epd](http://www.moso.eu/epd))
- FSC®: Products available with FSC® certification on request.
- Contribution LEED BD+C - v4: MR 1, MR 2, MR 3 (FSC®), SS 7 v2009: MR 6, MR 7 (FSC®)
- Contribution BREEAM: MAT 1, MAT 3 (FSC®), MAT 5 (HD)
- Warranty: 10 years

<sup>1)</sup> Tested on 18 mm thickness, without gaps between boards, with ventilation space behind boards.  
<sup>2)</sup> Tested on 3 years weathered MOSO® Bamboo X-treme®.

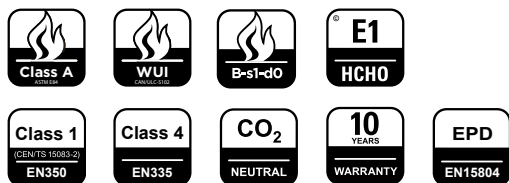

Only available on special request.



The mark of responsible forestry  
FSC® C002063



breeam

# MOSO® Bamboo X-treme®

## test results



The excellent performance of MOSO® Bamboo X-treme® has been extensively tested by acknowledged research institutes. Find a summary of the most important test results below. Full reports are available upon request. **Only MOSO® can ensure you have the original, unique Bamboo X-treme® product.** Copies of the original do not offer the same quality or level of durability, dimensional stability and ecology. With a look-alike product, there is a large risk of claims after installation. Always ask for the original, certified MOSO® Bamboo X-treme® products!



Durability of MOSO Bamboo X-treme, *Heat Treated Strand Woven Bamboo*: resistance against soft-rotting micro fungi according to CEN/TS 15083-2

---

Report code: 17.0083-C                      Date: 29 March 2017                      Page: 8/14

According to EN 350, the durability class is determined based on the x-value. To calculate the x-value, the median mass loss or the test species is compared to the median mass loss of the Beech or Pine references. Hardwoods are compared to Beech, Softwoods are compared to Pine. As Bamboo is neither softwood nor hardwood a comparison is made with both reference wood species Pine sapwood and Beech.

Based on the mass loss found and the comparison to Beech and Pine, the tested MOSO Bamboo X-treme, *Heat Treated Strand Woven Bamboo*, can be classified in durability class 1 when using the method described in EN 350.

MOSO Bamboo X-treme, *Heat Treated Strand Woven Bamboo*, performs comparable to Azobé and Merbau. Little variance is found between the different boards.

### durability

CEN/TS 15083-2  
(ENV 807) /  
EN 350

class 1



Durability of het treated strand woven bamboo: resistance against degradation by Basidiomycetes according to EN 350 and CEN/TS 15083-1

---

Report code: 17.0083-B                      Date: 29 March 2017                      Page: 8/14

According to EN 350, the durability class is calculated based on the mass loss obtained with the fungus resulting in the highest median mass loss. For all fungi the mass loss is less than 5%. This implies that, when using the EN 350 to determine the durability, MOSO Bamboo X-treme, *Heat Treated Strand Woven Bamboo* can be classified in durability class 1.

### durability

CEN/TS 15083-1  
(EN 113) /  
EN 350

class 1



Resistance of *Heat Treated Strand Woven Bamboo* against blue staining fungi

---

Report code: 9.061-E                      8 September, 2009                      Page: 10/10

#### 4 Conclusion

On behalf of Moso International BV an EN 152 blue stain test was performed on Heat Treated Strand Woven bamboo. UV- weathering was used as preconditioning of part of the samples. The combination of UV light and water spray resulted in strong discoloration of the surfaces of both the bamboo samples and the Pine sapwood reference samples.

Neither on the weathered nor on the original Bamboo samples discoloration of the blue stain fungi or the hyphae of the blue stain fungi could be observed. As a result it can be concluded that the susceptibility of this Heat Treated Strand Woven Bamboo towards blue stain is very low.

### resistance against surface fungi

(EN 152)

class 0

## harder and more durable than almost any other hardwood

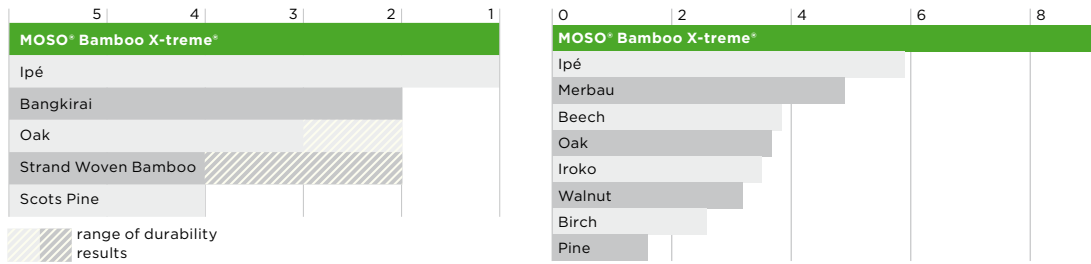

### durability class

CEN/TS 15083-2 / CEN/TS 15083-1 (EN 350)

class 1

### brinell hardness

(EN 1534)

9.5 kg/mm<sup>2</sup>

### use/risk class

(EN 350-1)

class 1

### Classification Durability Class

Use Class	1. very durable	2. durable	3. moderately durable	4. slightly durable	5. not durable
1 interior	o	o	o	o	o
2 moist interior	o	o	o	(o)	(o)
3 exterior, above ground	o	o	(o)	(o)-(x)	(o)-(x)
4 ground contact / fresh water	o	(o)	(x)	x	x
5 salt water	*	(x)	(x)	x	x

- o Natural durability sufficient.
- (o) Natural durability normally sufficient, but for certain end uses treatment may be advisable.
- (o)-(x) Natural durability may be sufficient, but depending on end use, preservative treatment may be necessary.
- (x) Preservative treatment is normally advisable.
- x Preservative treatment necessary.
- \* Natural durability of Bamboo X-treme® not tested in salt water.



### fire resistance

(EN 13501-1)

decking, 1x4 T&G

class Bfl-s1

siding, fascia/trim

boards, 2x beams

class B-s1-d0

### Classification ASTM E84

Classification	Flame Spread Index	Smoke Developed Index
A	0 - 25	0 - 450
B	26 - 75	0 - 450
C	76 - 200	0 - 450

### reaction to fire

(FSI 25 / SDI 45)

ASTM E84

class A

WUI approved

CAN/ULC-S102

### carbon footprint

ISO 14040/44

CO<sub>2</sub> neutral

Carbon Footprint (CO <sub>2</sub> eq) per kg final product					Eco-costs (€) per kg final product			
PRODUCTION	END OF LIFE	CO <sub>2</sub>	CO <sub>2</sub>	CO <sub>2</sub>	PRODUCTION	END OF LIFE	ECO-COSTS	ECO-COSTS
CO <sub>2</sub> footprint CO <sub>2</sub> eq/kg	CO <sub>2</sub> credit CO <sub>2</sub> eq/kg	Storage CO <sub>2</sub> eq/kg	Total CO <sub>2</sub> eq/kg	Neutral Y / N	Eco-costs Euro/kg	Eco-costs Euro/kg	CO <sub>2</sub> storage Euro/kg	Total Euro/kg
1.193	-0.704	-0.607	-0.118	Yes	0.356	-0.132	-0.082	0.142

The life cycle and the carbon footprint of MOSO products are evaluated according to ISO 14040/44. For more information: [www.moso.eu/lca](http://www.moso.eu/lca)  
The full report is available on request.

Confidential - This information is the property of MOSO International BV, Zwaag, the Netherlands. Any use or reproduction without permission will be prosecuted.

**Author:**  
Dr. Vogtlander J.G. (2014). Life Cycle Assessment and Carbon Sequestration - Update 2014 - Bamboo products of Moso International. Associate professor - Design for Sustainability - Delft University of Technology.

# the sustainability of Bamboo X-treme®

MOSO® Bamboo X-treme® offers clear sustainable advantages and is even proven to be CO2 neutral over its full life cycle! The inclusion of Bamboo X-treme® contributes to a higher LEED, BREEAM and Green Star certification score for green building projects. That's one of the reasons why you can find MOSO® Bamboo X-treme® and other MOSO® products in many sustainable reference projects all over the world.

## carbon footprint

### MOSO® Bamboo X-treme®: CO2 neutral over full life cycle

MOSO® has conducted an LCA and carbon footprint study together with Delft University of Technology (TU Delft) and INBAR. The report ([www.moso-bamboo.com/lca](http://www.moso-bamboo.com/lca)) concludes that all assessed MOSO® Products (all solid bamboo flooring, decking, beams, panels and veneer) are CO2 negative over the full life cycle ("cradle till grave"). In this result the high growth rate of Moso bamboo has not even been taken into account, and can be perceived as additional environmental benefit. The environmental impact of MOSO® Products, excluding carbon sequestration effect, was also published in an official Environmental Product Declaration (EPD) following EN 15804 ([www.moso-bamboo.com/epd](http://www.moso-bamboo.com/epd)).

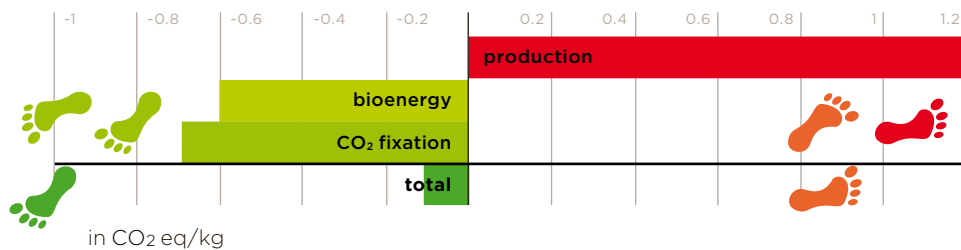

**Museo Del Gas** (7,500 sqft) Sabadell, Barcelona, Spain



## unsurpassed growing speed

### bamboo: the fastest growing plant in the world

Because of the fast growth, Moso bamboo is managed as an agricultural crop: the annual harvest of the 4 to 5-year-old stems - compared to 60-80 years for tropical hardwood! - provides a steady annual income to farmers and stimulates the bamboo plant to reproduce even faster. Therefore, by default, no deforestation occurs with production of MOSO® Bamboo X-treme®, while large amounts of CO2 are captured in the bamboo forests and products ([www.inbar.int/understanding-bamboos-climate-change-potential](http://www.inbar.int/understanding-bamboos-climate-change-potential)).

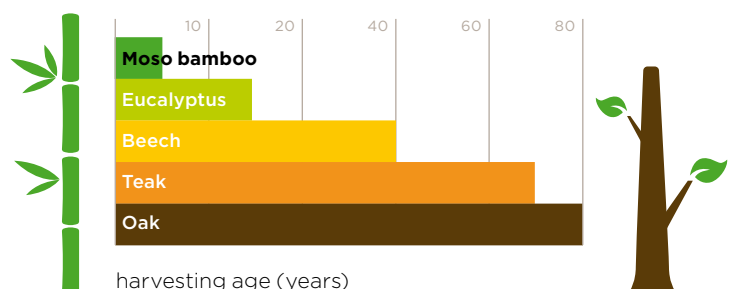



## carbon storage in bamboo

### biobased materials act as CO<sub>2</sub> sinks

Through photosynthesis, plants absorb carbon dioxide (CO<sub>2</sub>) and convert it into glucose (building block for biomass) and oxygen. The CO<sub>2</sub> is stored in the material for the lifetime of the product, and even longer if the product is recycled into new, durable products. Due to the fast growth – and related high yields – Moso bamboo locks far more CO<sub>2</sub> in durable products compared to wood species. The locked amount of CO<sub>2</sub> can be calculated rather simply by looking at the density of the material and taking into account the biobased content. For example, Bamboo X-treme® locks almost 1.700 kg CO<sub>2</sub> per m<sup>3</sup> of bamboo, which is the equivalent of the CO<sub>2</sub> emissions of 14.250 km driven by a mid-range car.

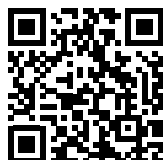
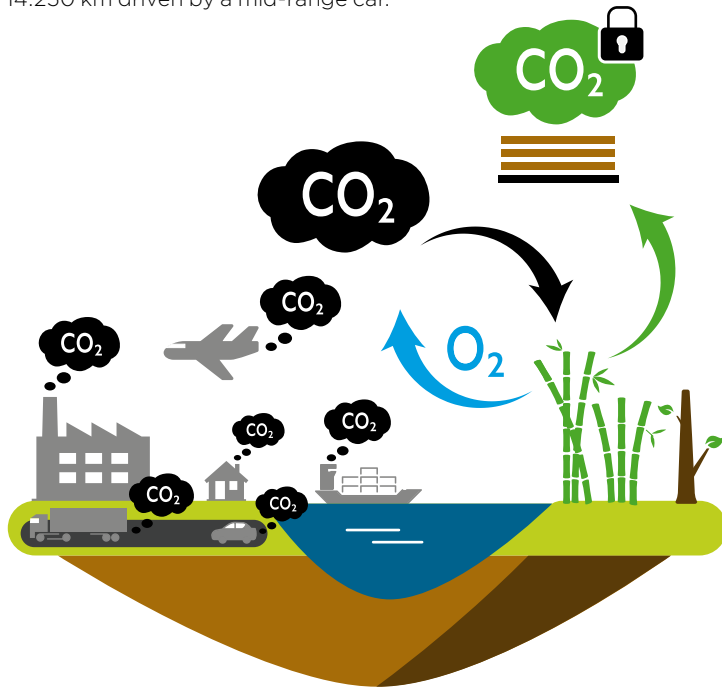

Check out how bamboo can save the world at:  
[www.moso-bamboo.com/sustainability](http://www.moso-bamboo.com/sustainability)

# MOSO®

## Bamboo X-treme®

### user information

#### appearance and color

MOSO® Bamboo X-treme® is a natural product, which can vary in color, grain and appearance. Color will change over time depending on the maintenance schedule. The boards have a brown to dark brown color when installed, which turns into a lighter caramel color several weeks after installation. Without further maintenance the color gets greyish relatively fast (similar to most other wood species).

Unfinished MOSO® Bamboo X-treme® can be left to weather naturally or can be finished 3-4 months after installation. If a brown color is preferred, maintenance should be done annually with Messmer's MOSO® Bamboo Finish Oil. For further details see the installation/maintenance instructions.

MOSO® Bamboo X-treme® shows similarity to other hardwoods in grain and structure. The characteristic bamboo nodes however can still be recognised and provide the product with a special and lively look.

#### low E window statement

Low-emissivity glass is designed to prevent heat gain inside the house but reflecting sunlight outward. This reflective property can result in excessive heat build on the surface of your X-treme® deck. The properties that Low-E glass employs to prevent passive heat gain within a structure can result in unusual heat build-up on exterior surfaces. When the sunlight is reflected and concentrated it can harm a range of building materials that include doors, windows, siding, trim and decking. Damage caused to these products can include melting, sagging, warping, discoloration, increased expansion and contraction and accelerated weathering.

#### normal phenomena

Micro-fissures on the surface and on the ends of the boards can arise from different drying characteristics of the surface and cross cut ends. This does not affect the stability or durability of the board. The surface side of the boards will become rougher over time and can form (small) splinters as a result of continuous water absorption and desorption due to dry and wet weather periods. Dimensional change or cupping of the boards can occur after installation. These phenomena are normal for most hardwood species and MOSO® Bamboo X-treme®.

After installation, there might be some bleeding or leaching of color from the bamboo material when it gets wet, e.g. when it rains. This possible bleeding is typical for wood and will disappear over time. The brownish liquid can easily be cleaned from the Bamboo X-treme® material, however controlled water drainage and prevention of splash water is required to prevent any discoloration of surrounding or underlying building components.

Water absorption can lead to a limited degree of grain raise. This can be mostly visible on a new deck, during and after rainfall, and will disappear when the deck is dry again. This phenomenon will occur less over time. This type of deformation of the surface is not considered to be a defect of the material.

snow condition





wet condition

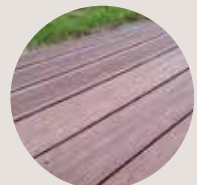

dry condition





there are **endless possibilities** and **custom made design products**

 The Meter Company  
 Dixieline Lumber  
 Hover Imagery

**La Jolla Private Residence** terrace installed with an overhanging deck - (900 sqft) Copa De Oro, La Jolla, United States of America





 Showcase Marketing  
 Rob Turner Studios

**Candlewood Lake Private Residence** decking installed for a marine dock with interesting design elements - Ohio, United States of America

**Del Mar Private Residence** siding installed to cover the façade of the house - (2,474 sqft) California, United States of America



 Guerrero Siding  
 J&W Lumber  
 John Leonffu

since 2008 over  
**45 million sqft**  
installed in more  
than **60 countries**

Fraser Decks & Patio Covers  
Hover Imagery

**High Bluff Ridge**  
(1,500 sqft) San Diego, CA, United States of America

**Jumbo Head office** photo taken 5 years after installation  
(27,000 sqft) Schiedam, The Netherlands



MVSA Architects  
Lior Teitler



Luc Richard

**Riberach Hotel** photo taken 8 years after installation  
(18,000 sqft) Bélesta, France

**Private Residence Candlewood Lake**  
(592 sqft) Ohio, United States of America



**Nordre Jarlsberg Brygge**  
(753 ft2 + 3.281 ft1) Selvikbukta, Norway



**Puku Ridge Safari Lodge**  
(13,993 ft) Zambia



## MOSO® Bamboo X-treme® : more than 45 million sqft installed around the world!

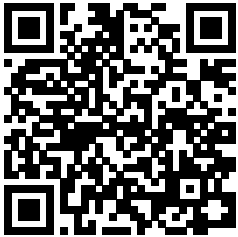

check out the **MOSO® Bamboo X-treme®** movies  
about maintenance and hardness at:  
[www.moso-bamboo.com/youtube/minutes](http://www.moso-bamboo.com/youtube/minutes)

North America:

**Moso North America Ltd.**  
PO Box 793, 1741 Valley Forge Road  
Worcester, PA 19490  
United States of America  
T: +1 855 343 8444  
[info@moso-bamboo.com](mailto:info@moso-bamboo.com)

Headquarters:

**Moso International B.V.**  
Adam Smithweg 2  
1689 ZW Zwaag  
The Netherlands  
T: +31 229 265 732  
[info@moso.eu](mailto:info@moso.eu)

Spain, France, Portugal, North Africa,  
Latin America and Middle East:

**Moso Europe S.L.U.**  
C/ Pau Claris, 83 - Principal 2ª  
08010 Barcelona  
Spain  
T: +34 93 574 9610  
[contact@moso.eu](mailto:contact@moso.eu)

Sub-Saharan Africa:

**Moso Africa Pty. Ltd.**  
7 Glosderry Road Kenilworth  
7708 Cape Town  
South Africa  
T: +27 2167 11214  
[contact@moso-bamboo.co.za](mailto:contact@moso-bamboo.co.za)

Gulf Cooperation Council  
(GCC) Countries:

**Moso Middle East LLC**  
Al Jafra-B, Ras Al Khor Industrial 1  
P.O. Box: 384421, Dubai  
United Arab Emirates  
T: +971 4 258 9337  
[contact@moso.ae](mailto:contact@moso.ae)

Italy:

**Moso Italia S.R.L**  
Via Antonio Locatelli 86  
20853 Biassono (MB)  
Italy  
T: +39 39 900 5440  
[mosoitalia@moso.eu](mailto:mosoitalia@moso.eu)

[www.moso-bamboo.com](http://www.moso-bamboo.com)



**bamboo  
products**